

Cabina di Trasformazione MT/BT

NUOVO QGBT
E PARALLELO TRASFORMATORI

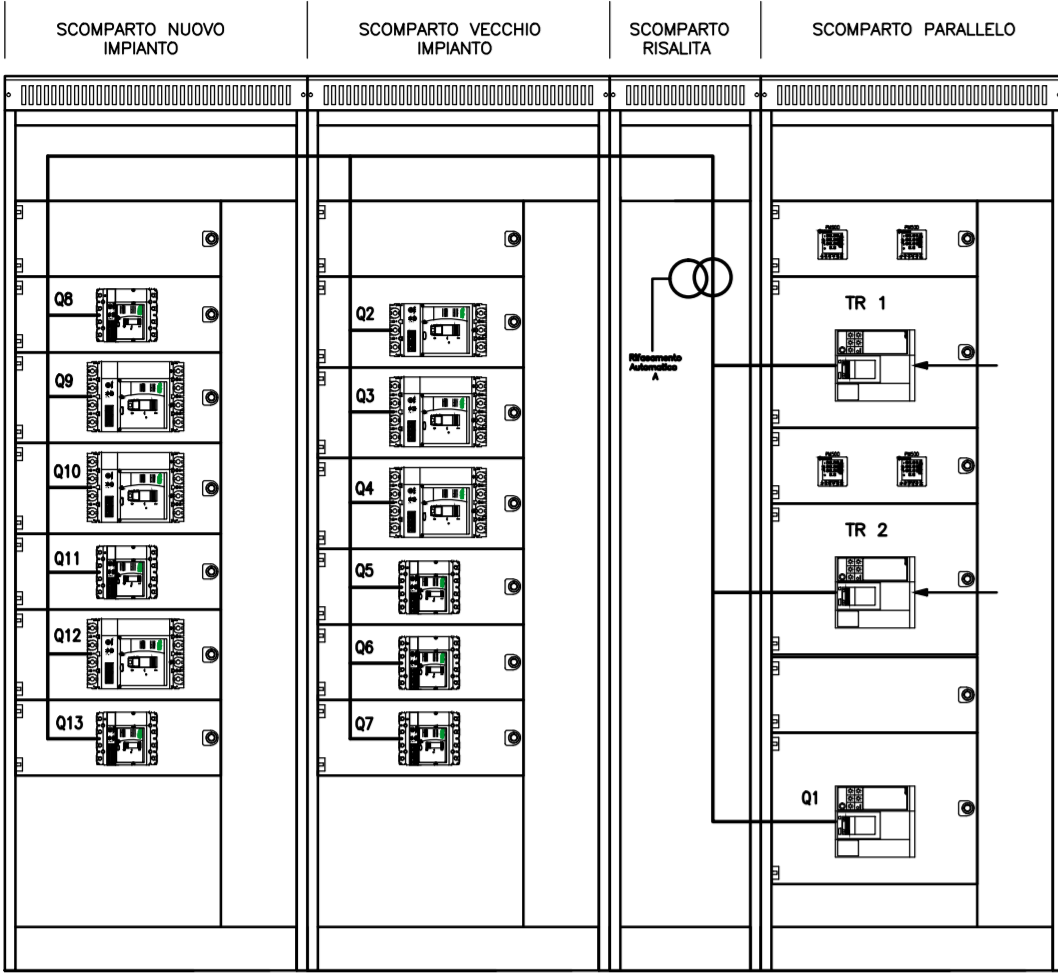

Locale
Capo
Impianto

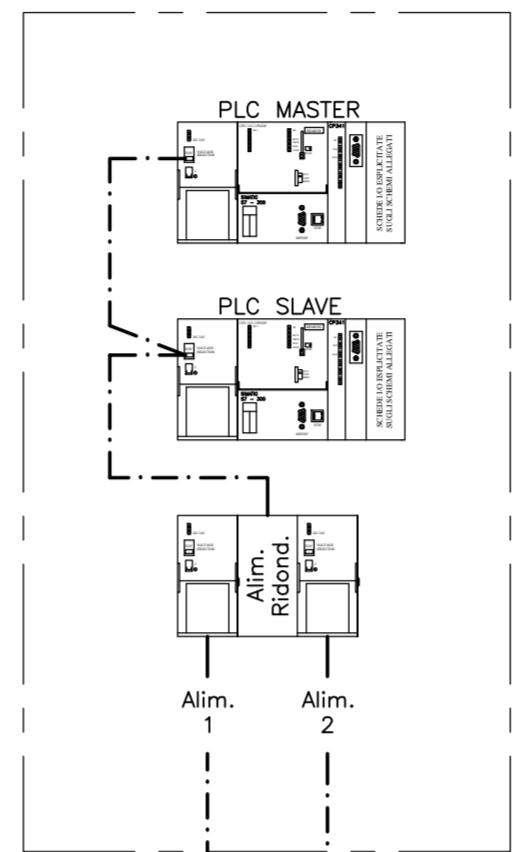

QMCC1

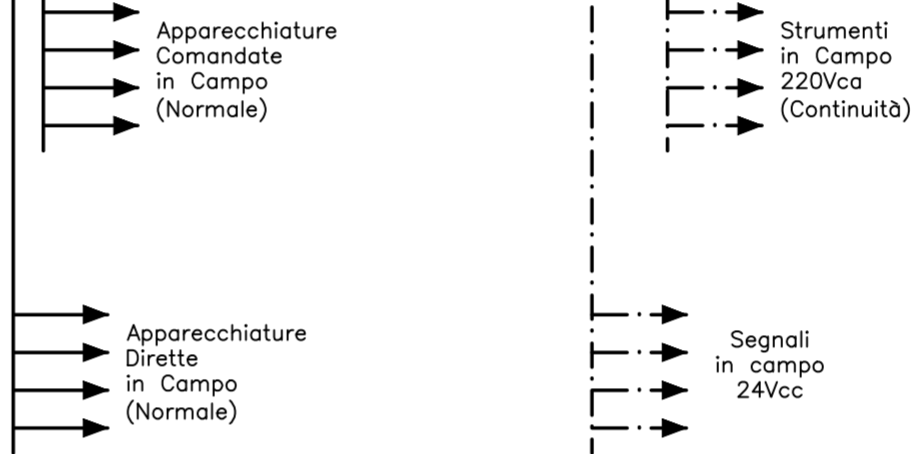
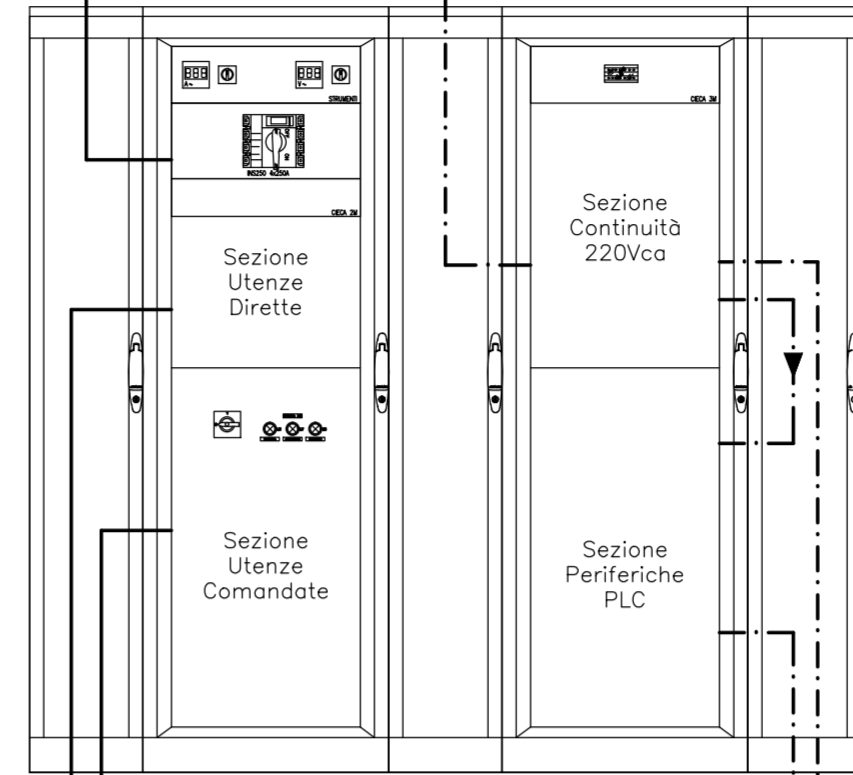

Quadro
Compressori
QCMP

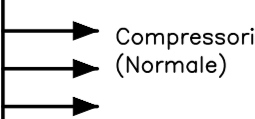
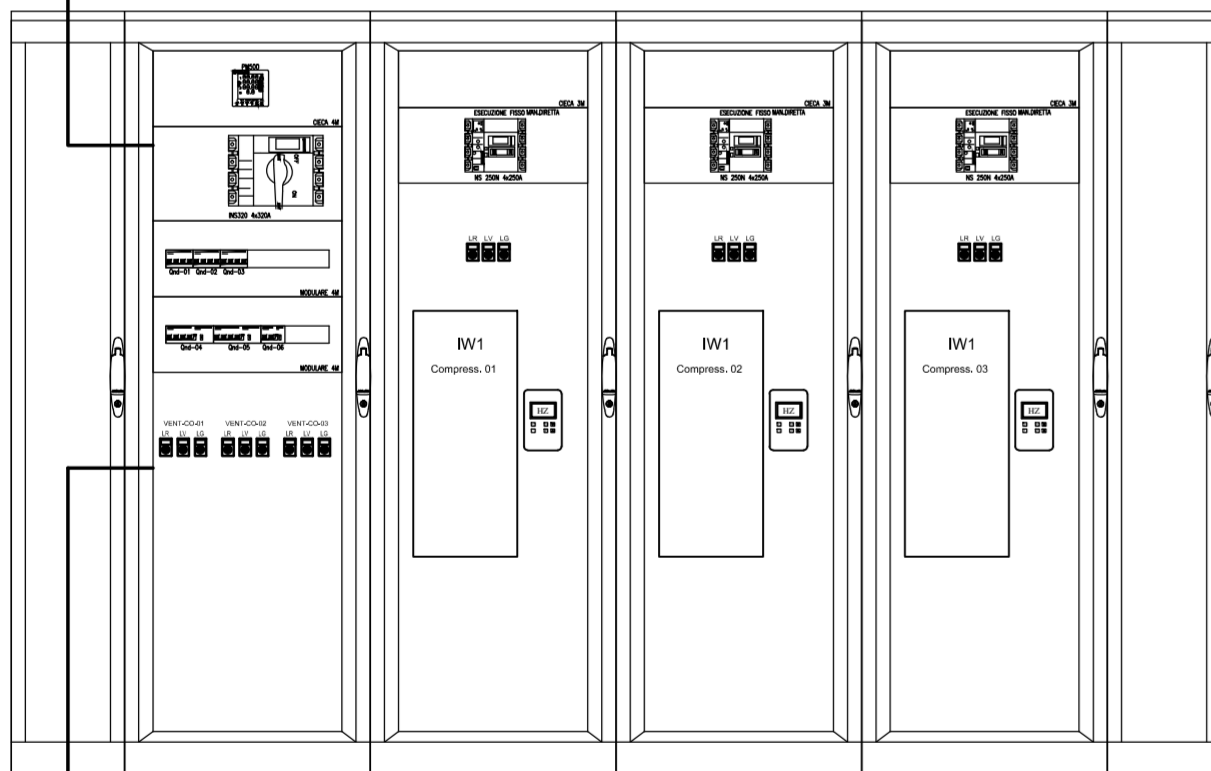

QMCC2

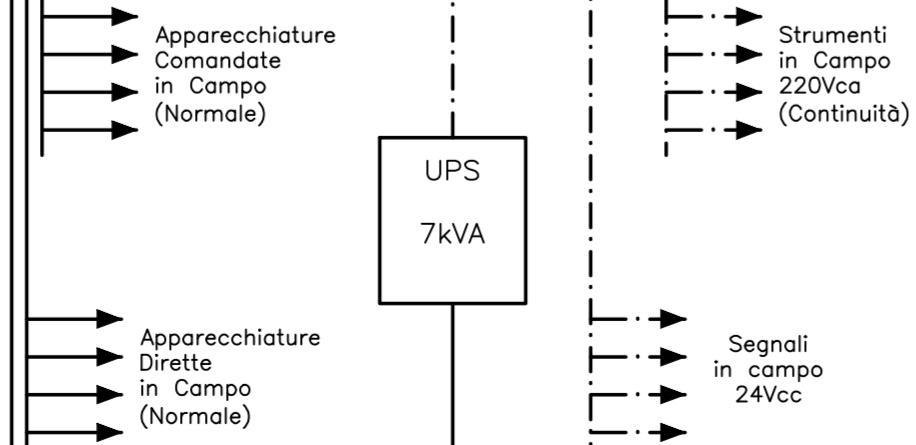
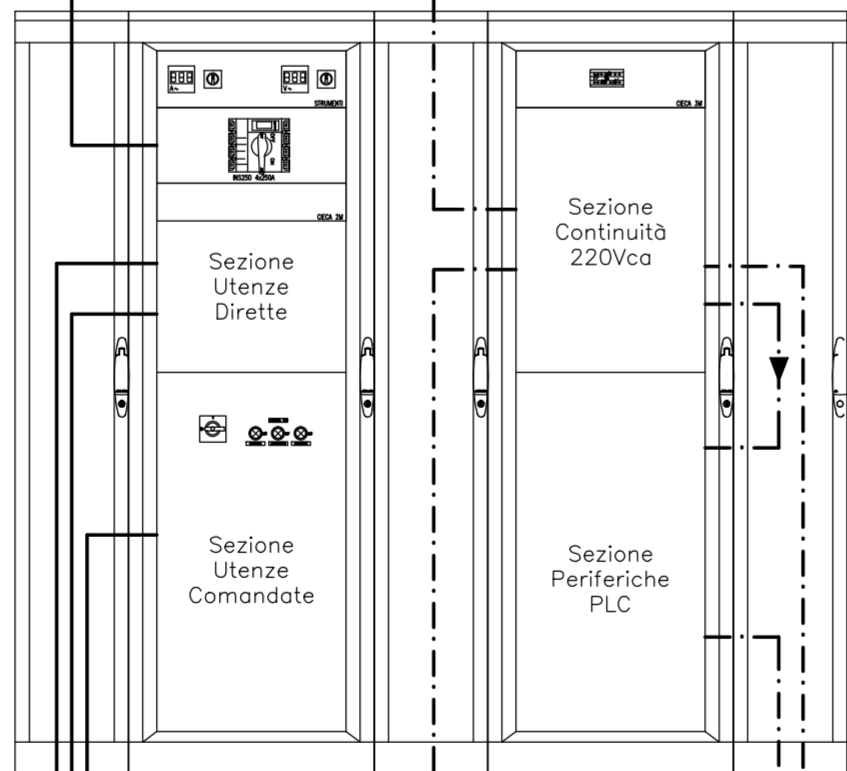

QMCC3

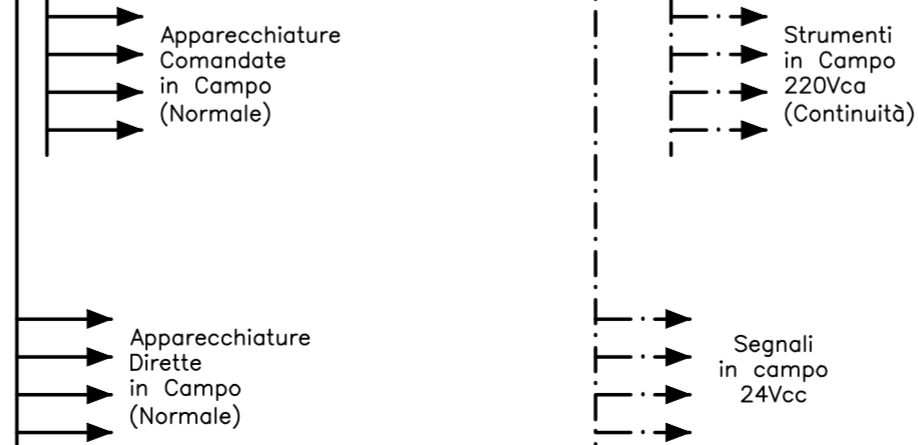
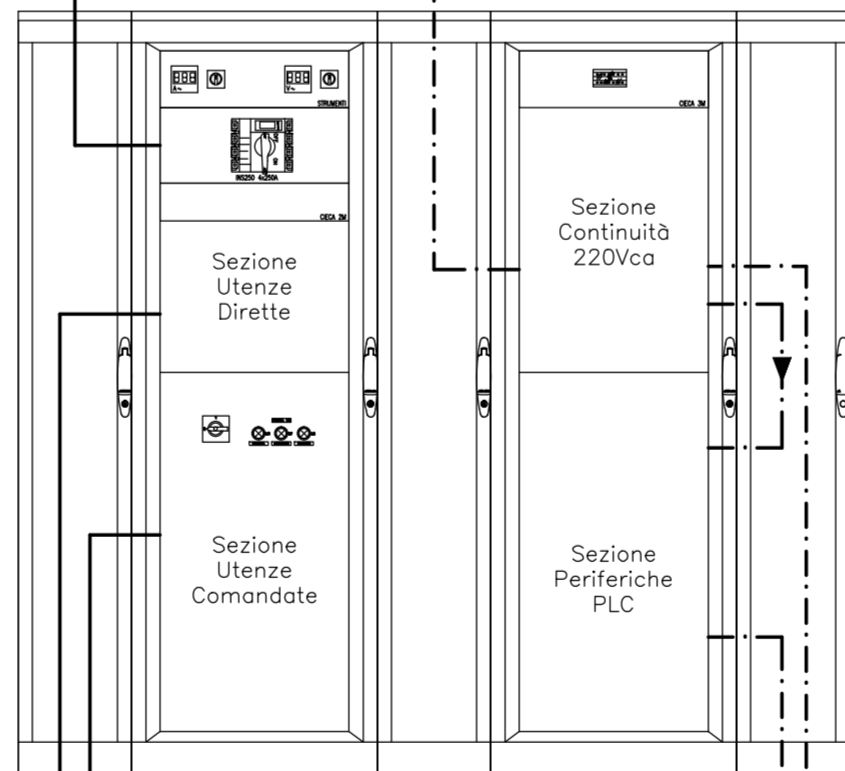

QMCC4

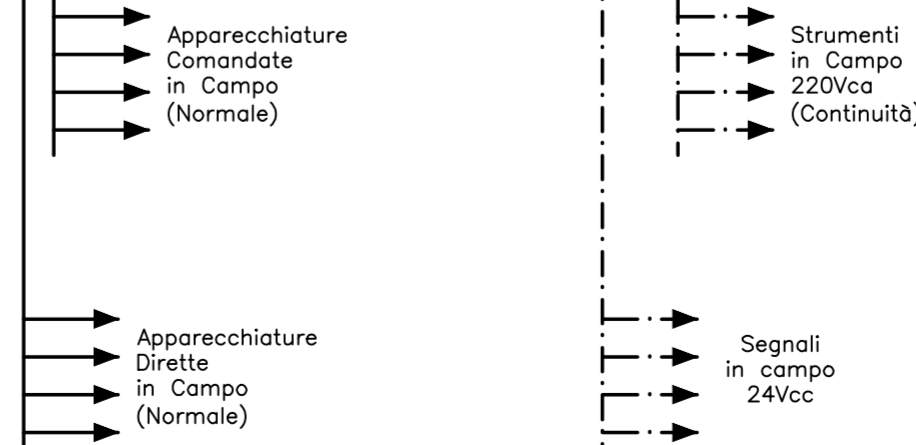
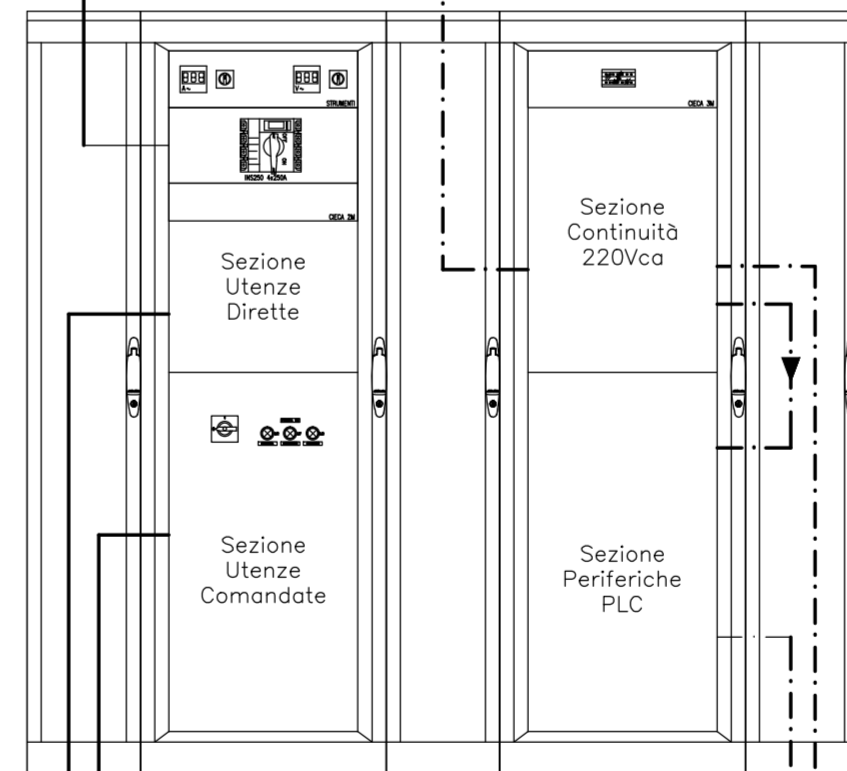

LEGENDA SIMBOLI

	Linea sezione normale
	Linea sezione emergenza
	Linea sezione continuità

REGIONE UMBRIA

A.T.I. N° 1 - A.T.I. N° 2

UMBRA ACQUE S.P.A.



**DISINQUINAMENTO
FIUME NESTORE
- 1° LOTTO -
ADEGUAMENTO
DELL'IMPIANTO DI
DEPURAZIONE DI
PIAN DELLA GENNA**

**COMUNE DI PERUGIA
LOC. PIAN DELLA GENNA**

PROGETTO COSTRUTTIVO

ATI:

CAPOGRUPPO



Franco Giuseppe s.r.l.
Impresa di costruzioni qualificata in progettazione e
realizzazione di opere pubbliche.
Sede legale via Sommano, 13
09047 Roccella Jonica - RC -

MANDANTE



Gestione e Trattamento Acque
Via Cancelliera, 25 00041-Abano Laziale (Rm)
Tel. 06.93.45.333 Fax. 06.93.45.667

TITOLO:

Schema a Blocchi di Potenza

Commessa Sez. E lab.

G501 IE 05

Scala

Data
Gennaio 2012

REV.	DATA	DESCRIZIONE	REDATTO	CONTROLL.	APP. TECN.
0	Gennaio 2012	PRIMA EMISSIONE	M.Denni	E.Panfilo	A.Scarpa
0	Luglio 2012	Aggiornamento Quadro elettrico generale di cabina MT/BT	M.Denni	E.Panfilo	A.Scarpa