

BENGHAZI - LIBYA - CITY HALL RESTORATION-



Architectural, electric and mechanical systems project

Architect in charge
and team coordinator:

Arch. Carlo Formichi

بغاز تنمية و تطوير
المراكز الادارية



DRAWING

ES10

WORKING DESIGN
PATTERNS OF ELECTRICAL
SWITCHBOARDS

SCALE /

DATE: 10 June 2009

UPDATING: July 2009

PROJECT NAME SOB_13

PLANT INPUT	
FAULT CURRENT ALLEGED ON PANELBOARD	9,678 [KA]
RATED VOLTAGE	400 (V)
RATED FREQUENCY	50 (Hz)
SYSTEM OF NEUTRAL	TT
PANELBOARD NAME	
PBGF1	
DP 31	SEGREGATION 3
NORMATIVE REFERENCE	
SWITCH	CEI EN 60947-2
MODULAR SWITCH	CEI EN 60947-2
	CEI EN 60898
PANELBOARD	CEI EN 60439-1
DIMENSION COPPER BARS	
In=	100 [A] lcc= 15,00[KA]

PANEL NAME
Panel Board Ground Floor 1

CLIENT :

Benghazi - Libia

OBJECT

City Hall Restoration

TABLE: 01

LEGEND SYMBOLS

SYMBOL	DESCRIPTION	SYMBOL	DESCRIPTION	SYMBOL	DESCRIPTION	SYMBOL	DESCRIPTION
	BATTERY ACCUMULATORI		PUSH SWITCH NO N.A.		CONTACTOR		METER
	RECTIFIER RADDRIZZATORE		PUSH SWITCH NC N.C.		PHASE WIRE		AMPEROMETRIC AND AMMETRIC SWITCH
	INVERTER C.C. - A.C.		SIGNAL LAMP		NEUTRAL WIRE		RELAY
	CONTROL ISOLATION "ISOLTESTER"		ELECTRIC SIREN		EXTRACTABLE SWITCH		DELAY TO DISEXCITATION RELAY
	AUXILIARY CONTACT NO		FUSE		SAFETY ISOLATING TRASFORMERS		DELAY TO EXCITATION RELAY
	AUXILIARY CONTACT NC		DIODE		TRANSFORMER		TWILIGHT SWITCH
	AUXILIARY CONTACT OF THERMAL RELAY NO		AUTOMATIC CIRCUIT BREAKER		RIDUTTORE DI CORRENTE (TA)		THREE PHASE MOTOR A.C.
	AUXILIARY CONTACT OF THERMAL RELAY NC		ISOLATOR		EARTH CONNECTION		MONO PHASE MOTOR A.C.
	AUXILIARY CONTACT TIMED TO THE EXCITATION NO		MAGNETIC AND THERMAL SWITCH		KEY LOCK		THREE PHASE CAPACITOR
	AUXILIARY CONTACT TIMED TO THE EXCITATION NC		MAGNETIC, THERMAL AND RESIDUAL CURRENT SWITCH		LOCK		
	AUXILIARY CONTACT TIMED TO THE DISEXCITATION NO		RESIDUAL CURRENT SWITCH		TIME SWITCH		
	AUXILIARY CONTACT TIMED TO THE DISEXCITATION NC		SWITCH		TERMINAL		
	PROXIMITY SWITCH NO		FUSE-DISCONNECTOR		VOLTMETER		
	PROXIMITY SWITCH NC		EARTHING SWITCH		AMPEROMETER		

PROJECT NAME SOB_13

PLANT INPUT	
FAULT CURRENT ALLEGED ON PANELBOARD	9,678 [kA]
RATED VOLTAGE	400 (V)
RATED FREQUENCY	50 (Hz)
SYSTEM OF NEUTRAL	TT
PANELBOARD NAME	
PBGF1	
DP 31	SEGREGATION 3
NORMATIVE REFERENCE	
SWITCH	CEI EN 60947-2
MODULAR SWITCH	CEI EN 60947-2
	CEI EN 60898
PANELBOARD	CEI EN 60439-1
DIMENSION COPPER BARS	
$I_n = 100$ [A]	$I_{cc} = 15,00$ [kA]

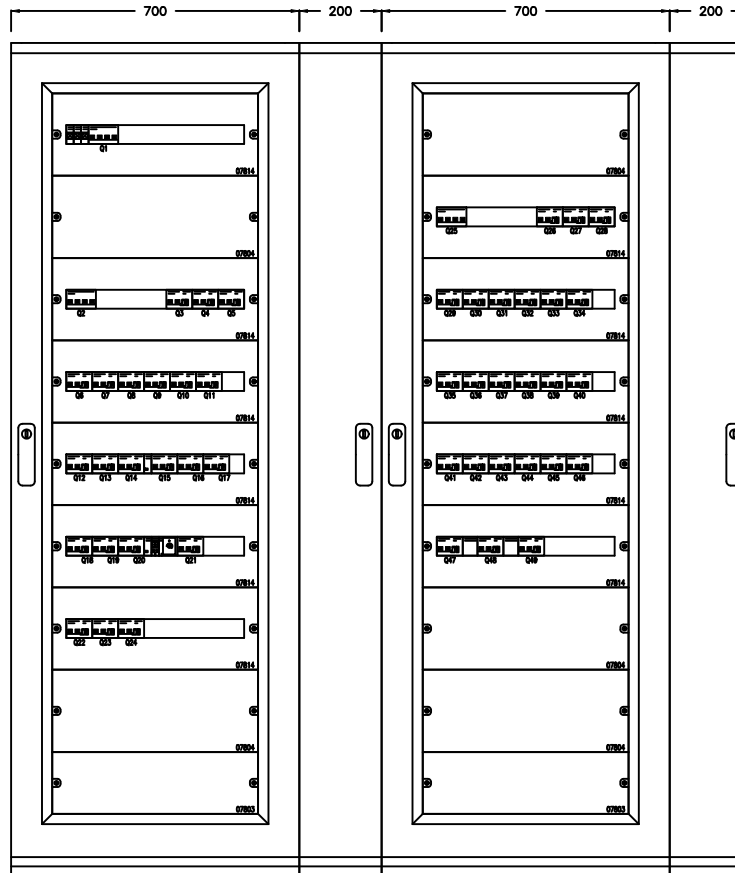

DIMENSION PANEL			
HEIGHT [mm]	: 2.000	BREADTH [mm]	: 1.800
DEPTH [mm]	: 400		

REFERENCE NUMBER OF DEVICE	1	2	3	4	5	6	7	8	9	10	11	12
PROJECT NAME	SOB_13											

PLANT INPUT	
FAULT CURRENT ALLEGED ON PANELBOARD	9,678 [kA]
RATED VOLTAGE	400 (V)
RATED FREQUENCY	50 (Hz)
SYSTEM OF NEUTRAL	TT
PANELBOARD NAME	
PBGF1	
DP 31	SEGREGATION 3
NORMATIVE REFERENCE	
SWITCH I	CEI EN 60947-2
MODULAR SWITCH	CEI EN 60947-2
	CEI EN 60898
PANELBOARD	CEI EN 60439-1
DIMENSION COPPER BARS	
In=	100 [A]
Icc=	15,00[kA]

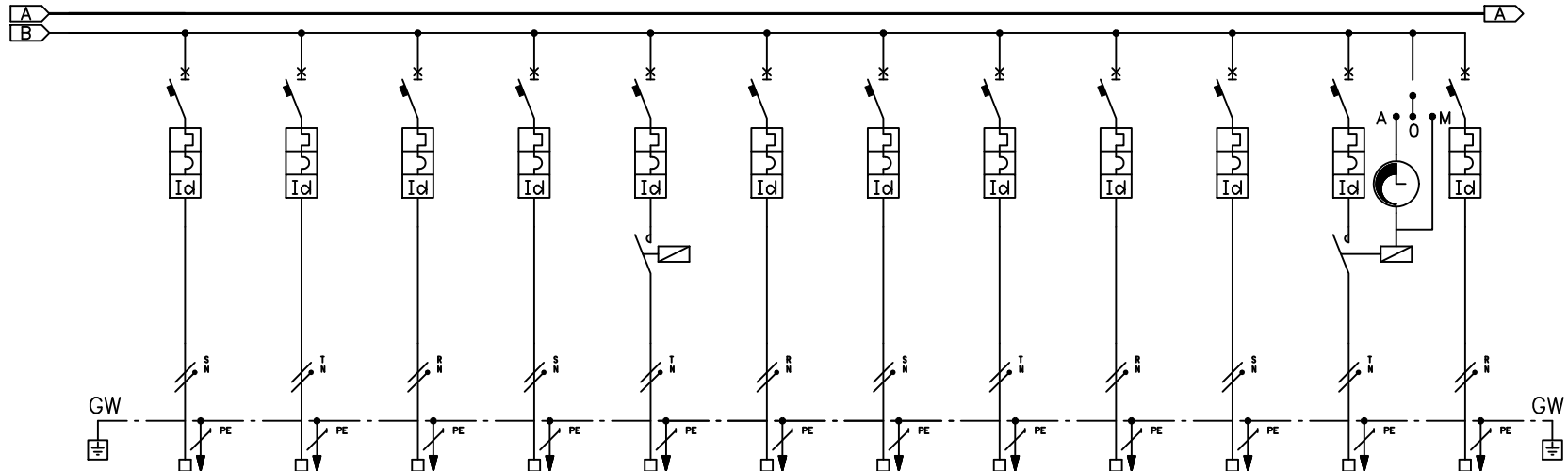

USER	SWITCH NAME	
	CIRCUIT NAME	
	DESCRIPTION OF THE CIRCUIT	
	INSTALLED ELECTRIC POWER	[kVA]
	INSTALLED ELECTRIC POWER	[kW]
	COEF. OF CONTEMPORANEITY	
	COEF. OF UTILISATION	
	USED ELECTRIC POWER	[kW]
	THREE OR MONO PHASE SYSTEM	
	VOLTAGE	[V]
Cos φ		
ELECTRICAL CURRENT USED	[A]	
DATA PANELBOARD	Icc ALLEGED	[kA]
	TYPE	
SWITCH OR DISCONNECTOR	SIZE	
	CHARACTERISTICS	
	MAGNETIC RELEASE I _{rm}	[A]
	THERMAL RELEASE I _{rh}	[A]
	BREAKING CAPACITY	[kA]
I _∞	[A ² t]	
RESIDUAL CURRENT DEVICE	RATED SENSITIVITY	[A]
	DELAY	[ms]
COMMAND DEVICE	TYPE	
	N. POLES x In	[A]
THERMAL RELAY	THERMAL RELEASE I _{rh}	[A]
FUSE	N. POLI x In	[A]
CONNECTION	SIZE	[mm ²]
	SETTING	
	TYPE	
	NO. OF CORES X AREA	[mm ²]
WIRE	GROUND WIRE (GW)	[mm ²]
	NO. OF WIRE X POLE	
	LENGTH	[m]
	ΔV%	[%]
CHECK	CURRENT CARRYING CAPACITY	[A]
	k ² s ²	[A ² t]
	MINIMUM Icc	[A]
	MAX Icc	[A]
WIRE	MAXIMUM LENGTH CHECKED	[m]

	Q10	Q11	Q12	Q13	Q14	Q15	Q16	Q17	Q18	Q19	Q20	Q21
L8	L9	L10	L11	L12	L13	L14	L15	L16	L17	L18	L19	
Office A 02-A 02a A 03	Room A 05 Room A 08	Room A 19 Room A 23	Room A 10	Garden A 37	Baths A 16,a,b,c A 18c,d,e	Stairs AVS01	Passage A 07a-A 08a	Passage A 18b-A 13	Passage A 11- A 11a	External Lighting	Emergency Lighting	
1,33	1,11	1,22	0,20	0,59	0,33	0,34	0,29	0,33	0,22	0,39	0,18	
1,20	1,00	1,10	0,18	0,53	0,30	0,31	0,26	0,30	0,20	0,35	0,16	
1,00	1,00	1,00	1,00	1,00	1,00	1,00	1,00	1,00	1,00	1,00	1,00	
1,00	1,00	1,00	1,00	1,00	1,00	1,00	1,00	1,00	1,00	1,00	1,00	
1,20	1,00	1,10	0,18	0,53	0,30	0,31	0,26	0,30	0,20	0,35	0,16	
M	M	M	M	M	M	M	M	M	M	M	M	
220	220	220	220	220	220	220	220	220	220	220	220	
0,90	0,90	0,90	0,90	0,90	0,90	0,90	0,90	0,90	0,90	0,90	0,90	
6,1	5,1	5,6	0,9	2,7	1,5	1,6	1,3	1,5	1,0	1,8	0,8	
9,678	9,678	9,678	9,678	9,678	9,678	9,678	9,678	9,678	9,678	9,678	9,678	
Modulare	Modulare	Modulare	Modulare	Modulare	Modulare	Modulare	Modulare	Modulare	Modulare	Modulare	Modulare	
2x10	2x10	2x10	2x6	2x6	2x6	2x6	2x6	2x6	2x6	2x6	2x6	
C	C	C	C	C	C	C	C	C	C	C	C	
100	100	100	60	60	60	60	60	60	60	60	60	
10,0	10,0	10,0	6,0	6,0	6,0	6,0	6,0	6,0	6,0	6,0	6,0	
15,0	15,0	15,0	15,0	15,0	15,0	15,0	15,0	15,0	15,0	15,0	10,0	
2,136E+04	2,136E+04	2,136E+04	1,007E+04	1,007E+04	1,007E+04	1,007E+04	1,007E+04	1,007E+04	1,007E+04	1,007E+04	1,007E+04	
0,03	0,03	0,03	0,03	0,03	0,03	0,03	0,03	0,03	0,03	0,03	0,03	
					RPP						AC3	
					2x16						2x16	
4	4	4	4	4	4	4	4	4	4	4	4	
B	B	B	B	B	B	B	B	B	B	B	B	
FG7	FG7	FG7	FG7	FG7	FG7	FG7	FG7	FG7	FG7	FG7	FG7	
3G2,5	3G2,5	3G2,5	3G2,5	3G2,5	3G2,5	3G2,5	3G2,5	3G2,5	3G2,5	3G2,5	3G2,5	
1	1	1	1	1	1	1	1	1	1	1	1	
70	50	60	20	40	40	50	50	60	50	130	70	
3,62	2,16	2,85	0,15	0,92	0,51	0,68	0,55	0,76	0,42	1,99	0,48	
31	31	31	31	31	31	31	31	31	31	31	31	
1,560E+05	1,560E+05	1,560E+05	1,560E+05	1,560E+05	1,560E+05	1,560E+05	1,560E+05	1,560E+05	1,560E+05	1,560E+05	1,560E+05	
152	213	178	533	267	267	213	213	178	213	82	152	
152	213	178	533	267	267	213	213	178	213	82	152	
107	107	107	178	178	178	178	178	178	178	178	178	

REFERENCE NUMBER OF DEVICE	1	2	3	4	5	6	7	8	9	10	11	12
PROJECT NAME	SOB_13											

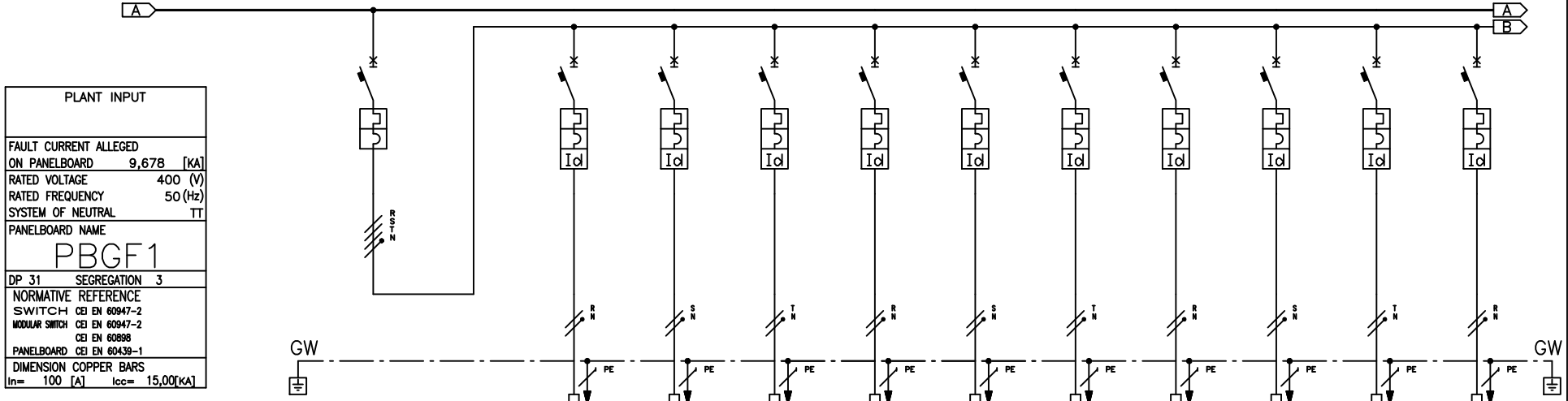

USER	SWITCH NAME	
	CIRCUIT NAME	
	DESCRIPTION OF THE CIRCUIT	
	INSTALLED ELECTRIC POWER	[kVA]
	INSTALLED ELECTRIC POWER	[kW]
	COEF. OF CONTEMPORANEITY	
	COEF. OF UTILISATION	
	USED ELECTRIC POWER	[kW]
	THREE OR MONO PHASE SYSTEM	
	VOLTAGE	[V]
Cos φ		
ELECTRICAL CURRENT USED	[A]	
DATA PANELBOARD	I _{cc} ALLEGED	[kA]
	TYPE	
SWITCH OR DISCONNECTOR	SIZE	
	CHARACTERISTICS	
	MAGNETIC RELEASE I _{rm}	[A]
	THERMAL RELEASE I _{rh}	[A]
	BREAKING CAPACITY	[kA]
RESIDUAL CURRENT DEVICE	I _{Δt}	[A²s]
	RATED SENSITIVITY	[A]
COMMAND DEVICE	DELAY	[ms]
	TYPE	
THERMAL RELAY	N. POLES x I _n	[A]
	THERMAL RELEASE I _{rh}	[A]
FUSE	N. POLI x I _n	[A]
	CONNECTION	[mm²]
WIRE	SETTING	
	TYPE	
	NO. OF CORES X AREA	[mm²]
	GROUND WIRE (GW)	[mm²]
	NO. OF WIRE X POLE	
CHECK	LENGTH	[m]
	ΔV%	[%]
	CURRENT CARRYING CAPACITY	[A]
	k²s²	[A²t]
	MINIMUM I _{cc}	[A]
WIRE	MAX I _{cc}	[A]
	MAXIMUM LENGTH CHECKED	[m]

	Q25	Q26	Q27	Q28	Q29	Q30	Q31	Q32	Q33	Q34	Q35
		FM1	FM2	FM3	FM4	FM5	FM6	FM7	FM8	FM9	FM10
Main socket switch		Office A 04	Office A 07	Office A 07	Office A 15	Office A 17	Office A 20-A 21	Office A 22	Office A 18-A 23	Office A 12-A 14	Office A 6-A 9
INSTALLED ELECTRIC POWER	24,88	1,13	1,75	1,13	0,63	1,63	2,25	1,75	1,13	2,13	1,88
INSTALLED ELECTRIC POWER	19,90	0,90	1,40	0,90	0,50	1,30	1,80	1,40	0,90	1,70	1,50
COEF. OF CONTEMPORANEITY	1,00	1,00	1,00	1,00	1,00	1,00	1,00	1,00	1,00	1,00	1,00
COEF. OF UTILISATION	1,00	1,00	1,00	1,00	1,00	1,00	1,00	1,00	1,00	1,00	1,00
USED ELECTRIC POWER	19,90	0,90	1,40	0,90	0,50	1,30	1,80	1,40	0,90	1,70	1,50
THREE OR MONO PHASE SYSTEM	T	M	M	M	M	M	M	M	M	M	M
VOLTAGE	380	220	220	220	220	220	220	220	220	220	220
Cos φ	0,80	0,80	0,80	0,80	0,80	0,80	0,80	0,80	0,80	0,80	0,80
ELECTRICAL CURRENT USED	37,8	5,1	8,0	5,1	2,8	7,4	10,2	8,0	5,1	9,7	8,5
I _{cc} ALLEGED	7,000	7,000	7,000	7,000	7,000	7,000	7,000	7,000	7,000	7,000	7,000
TYPE	Modulare	Modulare	Modulare	Modulare	Modulare	Modulare	Modulare	Modulare	Modulare	Modulare	Modulare
SIZE	4x50	2x16	2x16	2x16	2x16	2x16	2x16	2x16	2x16	2x16	2x16
CHARACTERISTICS	C	C	C	C	C	C	C	C	C	C	C
MAGNETIC RELEASE I _{rm}	500	160	160	160	160	160	160	160	160	160	160
THERMAL RELEASE I _{rh}	50,0	16,0	16,0	16,0	16,0	16,0	16,0	16,0	16,0	16,0	16,0
BREAKING CAPACITY	10,0	10,0	10,0	10,0	10,0	10,0	10,0	10,0	10,0	10,0	10,0
I _{Δt}	3,800E+04	1,600E+04	1,600E+04	1,600E+04	1,600E+04	1,600E+04	1,600E+04	1,600E+04	1,600E+04	1,600E+04	1,600E+04
RATED SENSITIVITY		0,03	0,03	0,03	0,03	0,03	0,03	0,03	0,03	0,03	0,03
DELAY											
TYPE											
N. POLES x I _n											
THERMAL RELEASE I _{rh}											
N. POLI x I _n											
CONNECTION		6	6	6	6	6	6	6	6	6	6
SETTING		B	B	B	B	B	B	B	B	B	B
TYPE		FG7	FG7	FG7	FG7	FG7	FG7	FG7	FG7	FG7	FG7
NO. OF CORES X AREA		3G4	3G4	3G4	3G4	3G4	3G4	3G4	3G4	3G4	3G4
GROUND WIRE (GW)											
NO. OF WIRE X POLE		1	1	1	1	1	1	1	1	1	1
LENGTH		60	60	60	60	60	60	60	60	60	60
ΔV%		1,45	2,27	1,45	0,79	2,10	2,90	2,27	1,45	2,75	2,41
CURRENT CARRYING CAPACITY		42	42	42	42	42	42	42	42	42	42
k²s²		3,994E+05	3,994E+05	3,994E+05	3,994E+05	3,994E+05	3,994E+05	3,994E+05	3,994E+05	3,994E+05	3,994E+05
MINIMUM I _{cc}		286	286	286	286	286	286	286	286	286	286
MAX I _{cc}		286	286	286	286	286	286	286	286	286	286
MAXIMUM LENGTH CHECKED		107	107	107	107	107	107	107	107	107	107

PROJECT NAME SOB_13

PLANT INPUT	
FAULT CURRENT ALLEGED ON PANELBOARD	1,837 [kA]
RATED VOLTAGE	400 (V)
RATED FREQUENCY	50 (Hz)
SYSTEM OF NEUTRAL	TT
PANELBOARD NAME	
PBGF2	
DP 31	SEGREGATION 3
NORMATIVE REFERENCE	
SWITCH	CEI EN 60947-2
MODULAR SWITCH	CEI EN 60947-2
	CEI EN 60898
PANELBOARD	CEI EN 60439-1
DIMENSION COPPER BARS	
In=	63 [A] Icc= 10,00[kA]

PANEL NAME
Panel Board Ground Floor 2

CLIENT :

Benghazi - Libia

OBJECT

City Hall Restoration

TABLE: 02

LEGEND SYMBOLS

SYMBOL	DESCRIPTION	SYMBOL	DESCRIPTION	SYMBOL	DESCRIPTION	SYMBOL	DESCRIPTION
	BATTERY ACCUMULATORI		PUSH SWITCH NO N.A.		CONTACTOR		METER
	RECTIFIER RADDRIZZATORE		PUSH SWITCH NC N.C.		PHASE WIRE		AMPEROMETRIC AND AMMETRIC SWITCH
	INVERTER C.C. - A.C.		SIGNAL LAMP		NEUTRAL WIRE		RELAY
	CONTROL ISOLATION "ISOLTESTER"		ELECTRIC SIREN		EXTRACTABLE SWITCH		DELAY TO DISEXCITATION RELAY
	AUXILIARY CONTACT NO		FUSE		SAFETY ISOLATING TRASFORMERS		DELAY TO EXCITATION RELAY
	AUXILIARY CONTACT NC		DIODE		TRANSFORMER		TWILIGHT SWITCH
	AUXILIARY CONTACT OF THERMAL RELAY NO		AUTOMATIC CIRCUIT BREAKER		RIDUTTORE DI CORRENTE (TA)		THREE PHASE MOTOR A.C.
	AUXILIARY CONTACT OF THERMAL RELAY NC		ISOLATOR		EARTH CONNECTION		MONO PHASE MOTOR A.C.
	AUXILIARY CONTACT TIMED TO THE EXCITATION NO		MAGNETIC AND THERMAL SWITCH		KEY LOCK		THREE PHASE CAPACITOR
	AUXILIARY CONTACT TIMED TO THE EXCITATION NC		MAGNETIC, THERMAL AND RESIDUAL CURRENT SWITCH		LOCK		
	AUXILIARY CONTACT TIMED TO THE DISEXCITATION NO		RESIDUAL CURRENT SWITCH		TIME SWITCH		
	AUXILIARY CONTACT TIMED TO THE DISEXCITATION NC		SWITCH		TERMINAL		
	PROXIMITY SWITCH NO		FUSE-DISCONNECTOR		VOLTMETER		
	PROXIMITY SWITCH NC		EARTHING SWITCH		AMPEROMETER		

PROJECT NAME SOB_13

PLANT INPUT	
FAULT CURRENT ALLEGED ON PANELBOARD	1,837 [kA]
RATED VOLTAGE	400 (V)
RATED FREQUENCY	50 (Hz)
SYSTEM OF NEUTRAL	TT
PANELBOARD NAME	
PBGF2	
DP 31	SEGREGATION 3
NORMATIVE REFERENCE	
SWITCH	CEI EN 60947-2
MODULAR SWITCH	CEI EN 60947-2
	CEI EN 60898
PANELBOARD	CEI EN 60439-1
DIMENSION COPPER BARS	
$I_n =$	63 [A] $I_{cc} =$ 10,00 [kA]

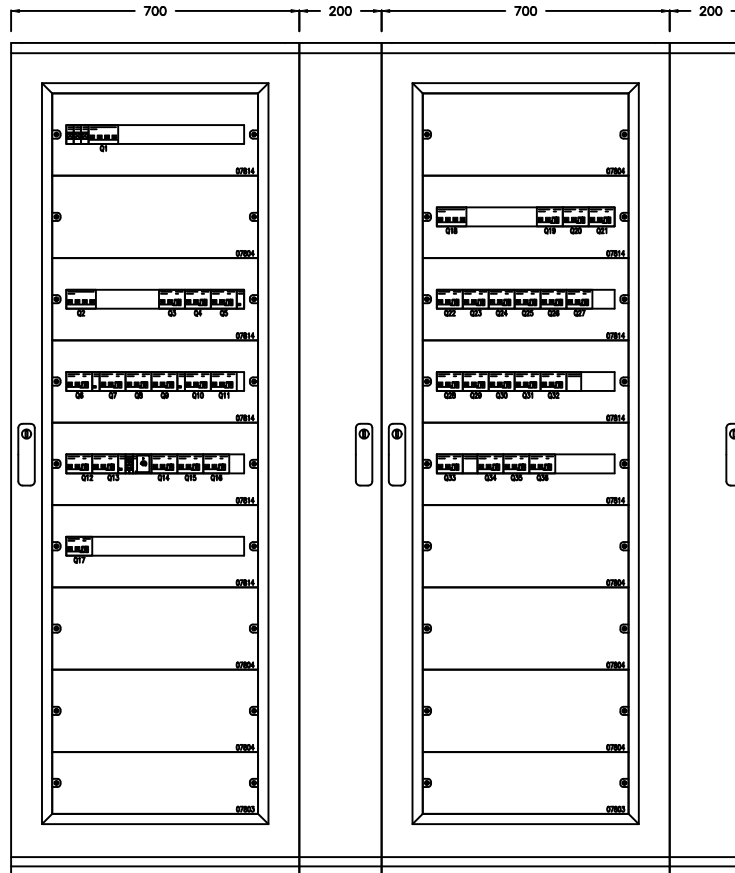

DIMENSION PANEL					
HEIGHT	2.000	BREADTH	1.800	DEPTH	400

PROJECT NAME S08_13

PLANT INPUT	
FAULT CURRENT ALLEGED ON PANELBOARD	1,837 [kA]
RATED VOLTAGE	400 (V)
RATED FREQUENCY	50 (Hz)
SYSTEM OF NEUTRAL	TT
PANELBOARD NAME	
PBGF2	
DP 31	SEGREGATION 3
NORMATIVE REFERENCE	
SWITCH	CEI EN 60947-2
MODULAR SWITCH	CEI EN 60947-2
	CEI EN 60898
PANELBOARD	CEI EN 60439-1
DIMENSION COPPER BARS	
$I_n =$	63 [A]
$I_{cc} =$	10,00 [kA]

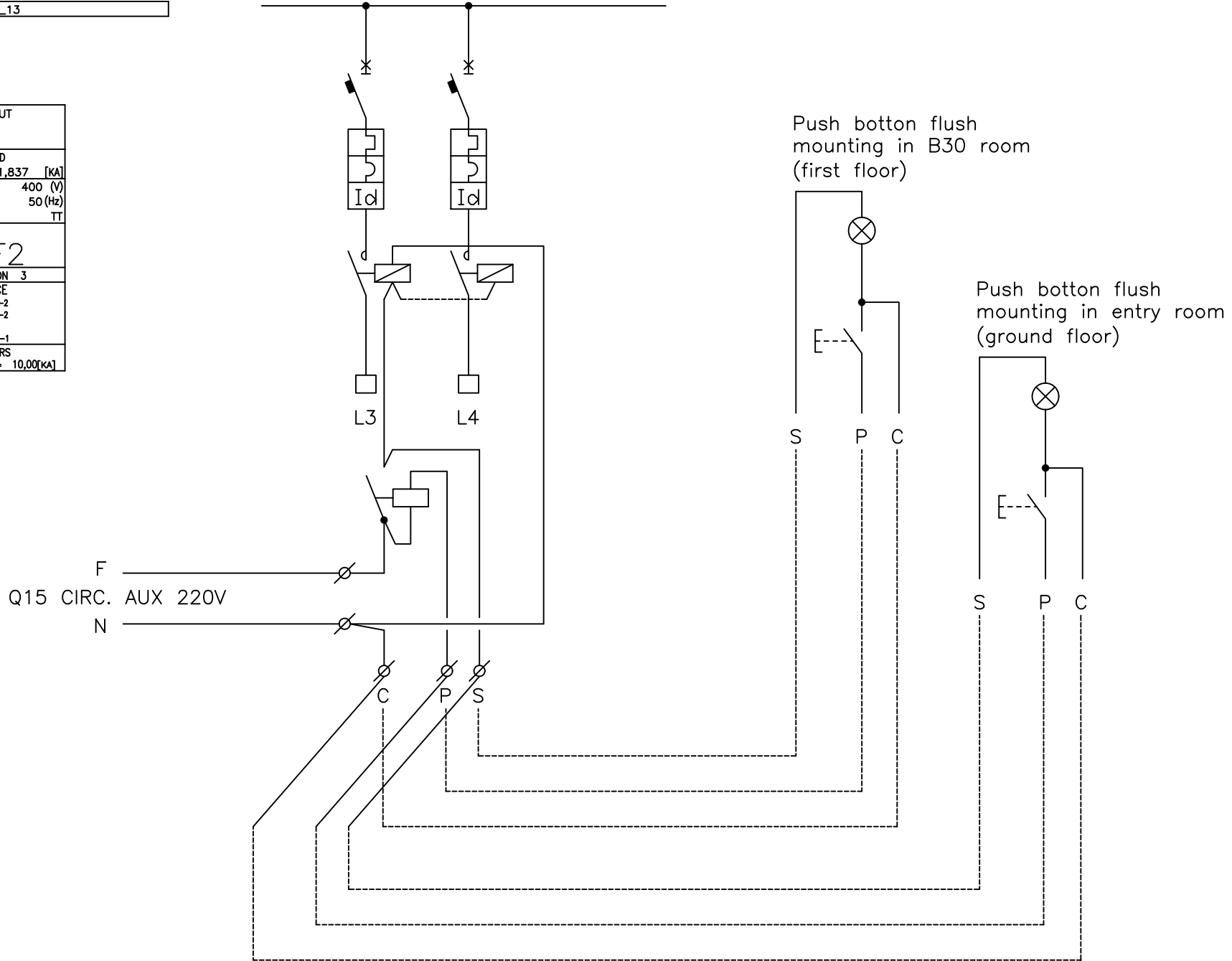

PROJECT NAME SOB_13

PLANT INPUT	
FAULT CURRENT ALLEGED ON PANELBOARD	6,990 [KA]
RATED VOLTAGE	400 (V)
RATED FREQUENCY	50 (Hz)
SYSTEM OF NEUTRAL	TT
PANELBOARD NAME	
PBFF1	
DP 31	SEGREGATION 3
NORMATIVE REFERENCE	
SWITCH	CEI EN 60947-2
MODULAR SWITCH	CEI EN 60947-2
	CEI EN 60898
PANELBOARD	CEI EN 60439-1
DIMENSION COPPER BARS	
In=	100 [A] lcc= 10,00[KA]

PANEL NAME
Panel Board First Floor 1

CLIENT :

Benghazi - Libia

OBJECT :

City Hall Restoration

TABLE: 03

LEGEND SYMBOLS

SYMBOL	DESCRIPTION	SYMBOL	DESCRIPTION	SYMBOL	DESCRIPTION	SYMBOL	DESCRIPTION
	BATTERY ACCUMULATORI		PUSH SWITCH NO N.A.		CONTACTOR		METER
	RECTIFIER RADDRIZZATORE		PUSH SWITCH NC N.C.		PHASE WIRE		AMPEROMETRIC AND AMMETRIC SWITCH
	INVERTER C.C. - A.C.		SIGNAL LAMP		NEUTRAL WIRE		RELAY
	CONTROL ISOLATION "ISOLTESTER"		ELECTRIC SIREN		EXTRACTABLE SWITCH		DELAY TO DISEXCITATION RELAY
	AUXILIARY CONTACT NO		FUSE		SAFETY ISOLATING TRASFORMERS		DELAY TO EXCITATION RELAY
	AUXILIARY CONTACT NC		DIODE		TRANSFORMER		TWILIGHT SWITCH
	AUXILIARY CONTACT OF THERMAL RELAY NO		AUTOMATIC CIRCUIT BREAKER		RIDUTTORE DI CORRENTE (TA)		THREE PHASE MOTOR A.C.
	AUXILIARY CONTACT OF THERMAL RELAY NC		ISOLATOR		EARTH CONNECTION		MONO PHASE MOTOR A.C.
	AUXILIARY CONTACT TIMED TO THE EXCITATION NO		MAGNETIC AND THERMAL SWITCH		KEY LOCK		THREE PHASE CAPACITOR
	AUXILIARY CONTACT TIMED TO THE EXCITATION NC		MAGNETIC, THERMAL AND RESIDUAL CURRENT SWITCH		LOCK		
	AUXILIARY CONTACT TIMED TO THE DISEXCITATION NO		RESIDUAL CURRENT SWITCH		TIME SWITCH		
	AUXILIARY CONTACT TIMED TO THE DISEXCITATION NC		SWITCH		TERMINAL		
	PROXIMITY SWITCH NO		FUSE-DISCONNECTOR		VOLTMETER		
	PROXIMITY SWITCH NC		EARTHING SWITCH		AMPEROMETER		

PROJECT NAME SOB_13

PLANT INPUT	
FAULT CURRENT ALLEGED ON PANELBOARD	6,990 [kA]
RATED VOLTAGE	400 (V)
RATED FREQUENCY	50 (Hz)
SYSTEM OF NEUTRAL	TT
PANELBOARD NAME	
PBFF1	
DP 31	SEGREGATION 3
NORMATIVE REFERENCE	
SWITCH	CEI EN 60947-2
MODULAR SWITCH	CEI EN 60947-2
	CEI EN 60898
PANELBOARD	CEI EN 60439-1
DIMENSION COPPER BARS	
I_n	100 [A]
I_{cc}	10,00 [kA]

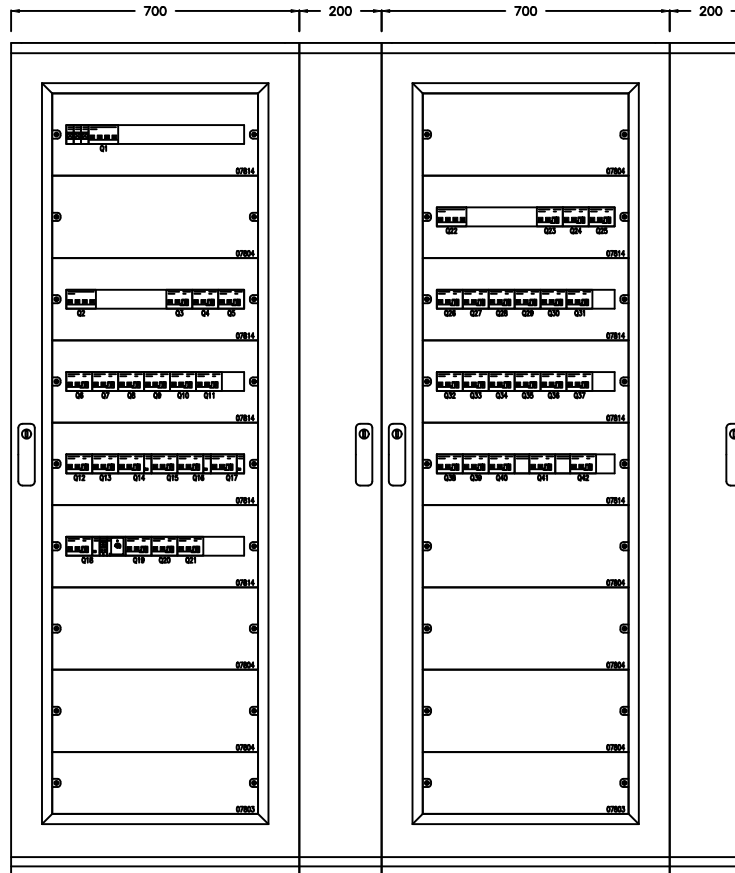

DIMENSION PANEL					
HEIGHT [mm]	2.000	BREADTH	1.800	DEPTH	400

REFERENCE NUMBER OF DEVICE	1	2	3	4	5	6	7	8	9	10	11	12
PROJECT NAME	SOB_13											

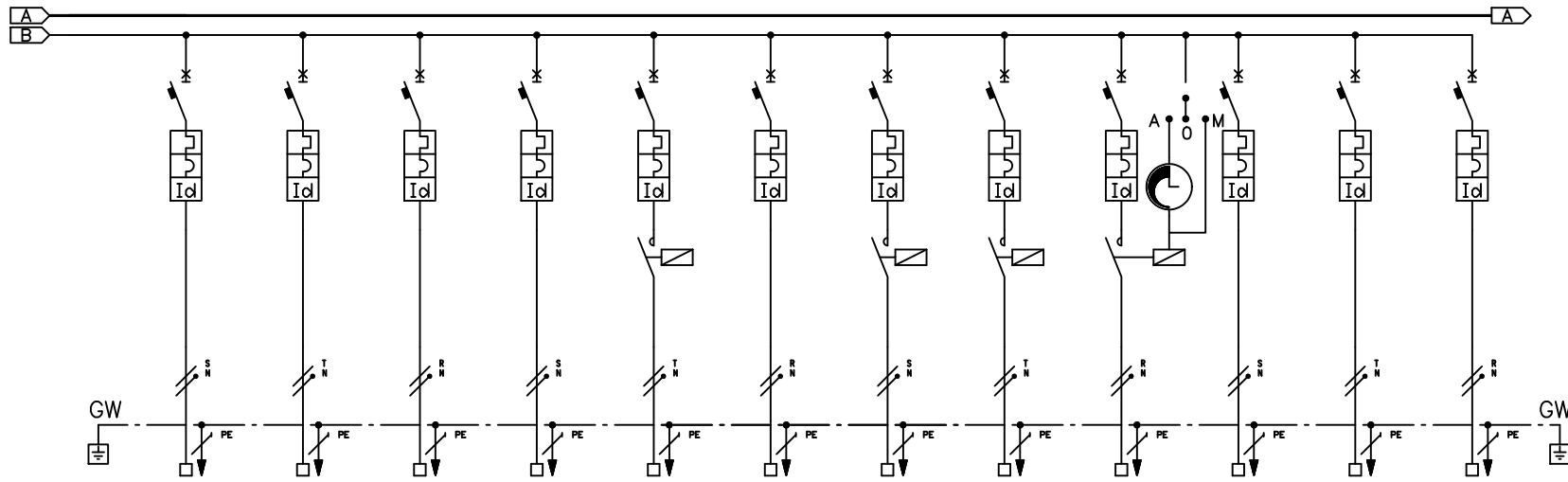

PLANT INPUT	
FAULT CURRENT ALLEGED ON PANELBOARD	6,990 [kA]
RATED VOLTAGE	400 (V)
RATED FREQUENCY	50 (Hz)
SYSTEM OF NEUTRAL	TT
PANELBOARD NAME	
PBFF1	
DP 31	SEGREGATION 3
NORMATIVE REFERENCE	
SWITCH	CEI EN 60947-2
MODULAR SWITCH	CEI EN 60947-2
	CEI EN 60898
PANELBOARD	CEI EN 60439-1
DIMENSION COPPER BARS	
In=	100 [A]
Icc=	10,00[kA]

USER	SWITCH NAME	
	CIRCUIT NAME	
	DESCRIPTION OF THE CIRCUIT	
	INSTALLED ELECTRIC POWER	[kVA]
	INSTALLED ELECTRIC POWER	[kW]
	COEF. OF CONTEMPORANEITY	
	COEF. OF UTILISATION	
	USED ELECTRIC POWER	[kW]
	THREE OR MONO PHASE SYSTEM	
	VOLTAGE	[V]
	Cos φ	
	ELECTRICAL CURRENT USED	[A]
DATA PANELBOARD	Icc ALLEGED	[kA]
	TYPE	
SWITCH OR DISCONNECTOR	SIZE	
	CHARACTERISTICS	
	MAGNETIC RELEASE I _{rm}	[A]
	THERMAL RELEASE I _{rh}	[A]
	BREAKING CAPACITY	[kA]
	I _{βt}	[A ^{2t}]
RESIDUAL CURRENT DEVICE	RATED SENSITIVITY	[A]
	DELAY	[ms]
COMMAND DEVICE	TYPE	
	N. POLES x In	[A]
THERMAL RELAY	THERMAL RELEASE I _{rh}	[A]
FUSE	N. POLI x In	[A]
CONNECTION	SIZE	[mm ²]
WIRE	SETTING	
	TYPE	
	NO. OF CORES X AREA	[mm ²]
	GROUND WIRE (GW)	[mm ²]
	NO. OF WIRE X POLE	
	LENGTH	[m]
CHECK	ΔV%	[%]
	CURRENT CARRYING CAPACITY	[A]
	k ² s ²	[A ^{2t}]
	MINIMUM Icc	[A]
WIRE	MAX Icc	[A]
	MAXIMUM LENGTH CHECKED	[m]

Q10	Q11	Q12	Q13	Q14	Q15	Q16	Q17	Q18	Q19	Q20	Q21
L8	L9	L10	L11	L12	L13	L14	L15	L16	L17		
Office B03 B04-007	Office B02 B06	Room B16	B21-B21b-B21c-B22-B22b-B22c	Stairs B_Vs01	Room B25 B28	Passage B11-B11a-B22a	Passage B13-B21a	External Lighting	Emergency Lighting	Spare	Spare
1,33	1,00	0,20	0,22	0,33	1,33	0,50	0,33	0,39	0,23		
1,20	0,90	0,18	0,20	0,30	1,20	0,45	0,30	0,35	0,21		
1,00	1,00	1,00	1,00	1,00	1,00	1,00	1,00	1,00	1,00		
1,00	1,00	1,00	1,00	1,00	1,00	1,00	1,00	1,00	1,00		
1,20	0,90	0,18	0,20	0,30	1,20	0,45	0,30	0,35	0,21		
M	M	M	M	M	M	M	M	M	M		
220	220	220	220	220	220	220	220	220	220		
0,90	0,90	0,90	0,90	0,90	0,90	0,90	0,90	0,90	0,90		
6,1	4,5	0,9	1,0	1,5	6,1	2,3	1,5	1,8	1,1		
6,990	6,990	6,990	6,990	6,990	6,990	6,990	6,990	6,990	6,990	6,990	6,990
Modulare	Modulare	Modulare	Modulare	Modulare	Modulare	Modulare	Modulare	Modulare	Modulare	Modulare	Modulare
2x10	2x10	2x10	2x6	2x6	2x10	2x6	2x6	2x6	2x6	2x10	2x10
C	C	C	C	C	C	C	C	C	C	C	C
100	100	100	60	60	100	60	60	60	60	100	100
10,0	10,0	10,0	6,0	6,0	10,0	6,0	6,0	6,0	6,0	10,0	10,0
10,0	10,0	10,0	10,0	10,0	10,0	10,0	10,0	10,0	10,0	10,0	10,0
1,598E+04	1,598E+04	1,598E+04	8,995E+03	8,995E+03	1,598E+04	8,995E+03	8,995E+03	8,995E+03	8,995E+03	1,598E+04	1,598E+04
0,03	0,03	0,03	0,03	0,03	0,03	0,03	0,03	0,03	0,03	0,03	0,03
				AC3		AC3	AC3	AC3			
				2x16		2x16	2x16	2x16			
4	4	4	4	4	4	4	4	4	4	4	4
B	B	B	B	B	B	B	B	B	B	B	B
FG7	FG7	FG7	FG7	FG7	FG7	FG7	FG7	FG7	FG7	FG7	FG7
3G2,5	3G2,5	3G2,5	3G2,5	3G2,5	3G2,5	3G2,5	3G2,5	3G2,5	3G2,5	3G2,5	3G2,5
1	1	1	1	1	1	1	1	1	1	1	1
70	50	60	20	50	50	60	50	130	70		
3,62	1,91	0,46	0,17	0,64	2,59	1,17	0,64	1,99	0,65		
31	31	31	31	31	31	31	31	31	31		
1,560E+05	1,560E+05	1,560E+05	1,560E+05	1,560E+05	1,560E+05	1,560E+05	1,560E+05	1,560E+05	1,560E+05	1,560E+05	1,560E+05
152	213	178	532	213	213	178	213	82	152		
152	213	178	532	213	213	178	213	82	152		
107	107	107	178	178	107	178	178	178	178		

PROJECT NAME SOB_13

PLANT INPUT	
FAULT CURRENT ALLEGED ON PANELBOARD	1,537 [KA]
RATED VOLTAGE	400 (V)
RATED FREQUENCY	50 (Hz)
SYSTEM OF NEUTRAL	TT
PANELBOARD NAME	
PBFF2	
DP 31	SEGREGATION 3
NORMATIVE REFERENCE	
SWITCH	CEI EN 60947-2
MODULAR SWITCH	CEI EN 60947-2
	CEI EN 60898
PANELBOARD	CEI EN 60439-1
DIMENSION COPPER BARS	
In=	63 [A] Icc= 10,00[KA]

PANEL NAME
Panel Board First Floor 2

CLIENT :



















































Benghazi - Libia

OBJECT :

City Hall Restoration

TABLE: 04

LEGEND SYMBOLS

SYMBOL	DESCRIPTION	SYMBOL	DESCRIPTION	SYMBOL	DESCRIPTION	SYMBOL	DESCRIPTION
	BATTERY ACCUMULATORI		PUSH SWITCH NO N.A.		CONTACTOR		METER
	RECTIFIER RADDRIZZATORE		PUSH SWITCH NC N.C.		PHASE WIRE		AMPEROMETRIC AND AMMETRIC SWITCH
	INVERTER C.C. - A.C.		SIGNAL LAMP		NEUTRAL WIRE		RELAY
	CONTROL ISOLATION "ISOLTESTER"		ELECTRIC SIREN		EXTRACTABLE SWITCH		DELAY TO DISEXCITATION RELAY
	AUXILIARY CONTACT NO		FUSE		SAFETY ISOLATING TRASFORMERS		DELAY TO EXCITATION RELAY
	AUXILIARY CONTACT NC		DIODE		TRANSFORMER		TWILIGHT SWITCH
	AUXILIARY CONTACT OF THERMAL RELAY NO		AUTOMATIC CIRCUIT BREAKER		RIDUTTORE DI CORRENTE (TA)		THREE PHASE MOTOR A.C.
	AUXILIARY CONTACT OF THERMAL RELAY NC		ISOLATOR		EARTH CONNECTION		MONO PHASE MOTOR A.C.
	AUXILIARY CONTACT TIMED TO THE EXCITATION NO		MAGNETIC AND THERMAL SWITCH		KEY LOCK		THREE PHASE CAPACITOR
	AUXILIARY CONTACT TIMED TO THE EXCITATION NC		MAGNETIC, THERMAL AND RESIDUAL CURRENT SWITCH		LOCK		
	AUXILIARY CONTACT TIMED TO THE DISEXCITATION NO		RESIDUAL CURRENT SWITCH		TIME SWITCH		
	AUXILIARY CONTACT TIMED TO THE DISEXCITATION NC		SWITCH		TERMINAL		
	PROXIMITY SWITCH NO		FUSE-DISCONNECTOR		VOLTMETER		
	PROXIMITY SWITCH NC		EARTHING SWITCH		AMPEROMETER		

PROJECT NAME SOB_13

PLANT INPUT	
FAULT CURRENT ALLEGED ON PANELBOARD	1,537 [kA]
RATED VOLTAGE	400 (V)
RATED FREQUENCY	50 (Hz)
SYSTEM OF NEUTRAL	TT
PANELBOARD NAME	
PBFF2	
DP 31	SEGREGATION 3
NORMATIVE REFERENCE	
SWITCH	CEI EN 60947-2
MODULAR SWITCH	CEI EN 60947-2
	CEI EN 60898
PANELBOARD	CEI EN 60439-1
DIMENSION COPPER BARS	
$I_n =$	63 [A] $I_{cc} =$ 10,00 [kA]

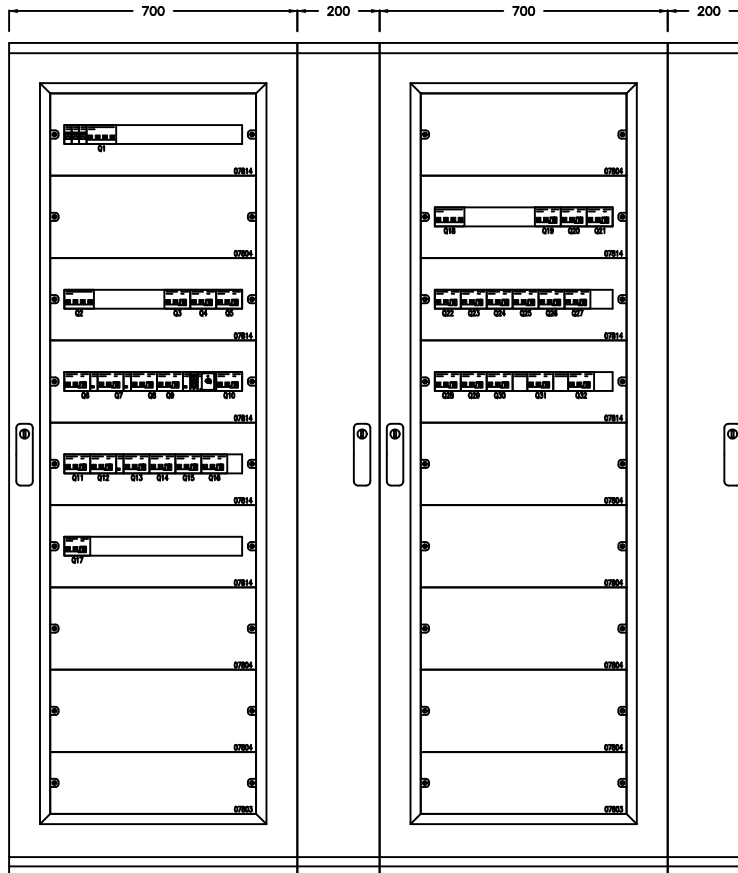

DIMENSION PANEL					
HEIGHT [mm] :	2.000	BREADTH [mm]	1.800	DEPTH [mm]	400

REFERENCE NUMBER OF DEVICE	1	2	3	4	5	6	7	8	9	10	11	12
PROJECT NAME	SOB_13											

PLANT INPUT	
FAULT CURRENT ALLEGED ON PANELBOARD	1,537 [kA]
RATED VOLTAGE	400 (V)
RATED FREQUENCY	50 (Hz)
SYSTEM OF NEUTRAL	TT
PANELBOARD NAME	
PBF2	
DP 31	SEGREGATION 3
NORMATIVE REFERENCE	
SWITCH	CEI EN 60947-2
MODULAR SWITCH	CEI EN 60947-2
	CEI EN 60898
PANELBOARD	CEI EN 60439-1
DIMENSION COPPER BARS	
In=	63 [A] lcc= 10,00[kA]

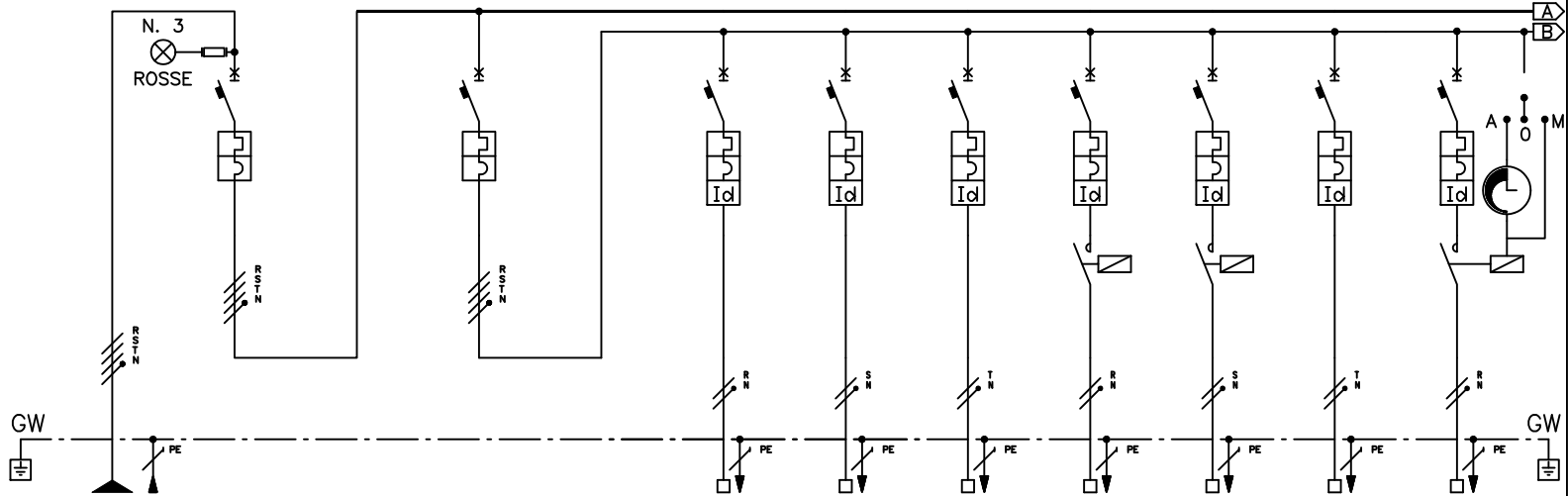

USER	SWITCH NAME	
	CIRCUIT NAME	
	DESCRIPTION OF THE CIRCUIT	
	INSTALLED ELECTRIC POWER	[kVA]
	INSTALLED ELECTRIC POWER	[kW]
	COEF. OF CONTEMPORANEITY	
	COEF. OF UTILISATION	
	USED ELECTRIC POWER	[kW]
	THREE OR MONO PHASE SYSTEM	
	VOLTAGE	[V]
	Cos φ	
	ELECTRICAL CURRENT USED	[A]
DATA PANELBOARD	Icc ALLEGED	[kA]
	TYPE	
SWITCH OR DISCONNECTOR	SIZE	
	CHARACTERISTICS	
	MAGNETIC RELEASE I _{rm}	[A]
	THERMAL RELEASE I _{rh}	[A]
	BREAKING CAPACITY	[kA]
	I _{βt}	[A ² t]
RESIDUAL CURRENT DEVICE	RATED SENSITIVITY	[A]
	DELAY	[ms]
COMMAND DEVICE	TYPE	
	N. POLES x I _n	[A]
THERMAL RELAY	THERMAL RELEASE I _{rh}	[A]
FUSE	N. POLI x I _n	[A]
CONNECTION	SIZE	[mm ²]
WIRE	SETTING	
	TYPE	
	NO. OF CORES X AREA	[mm ²]
	GROUND WIRE (GW)	[mm ²]
	NO. OF WIRE X POLE	
	LENGTH	[m]
CHECK	Δ V%	[%]
	CURRENT CARRYING CAPACITY	[A]
	k ² s ²	[A ² t]
	MINIMUM I _{cc}	[A]
	MAX I _{cc}	[A]
	MAXIMUM LENGTH CHECKED	[m]

	Q1	Q2	Q3	Q4	Q5	Q6	Q7	Q8	Q9
	Main panel switch	Main lighting switch	Office B36 1 floor	Room B31-B32 1 floor	Room B33 1 floor	Stairs 1-2 floor	Passage B30 1 floor	Room B34 1 floor	External Lighting 1-2 floor
	15,74	6,18	0,83	1,13	0,24	0,48	0,73	0,56	0,89
	12,60	5,57	0,75	1,02	0,22	0,43	0,66	0,50	0,80
	1,00	1,00	1,00	1,00	1,00	1,00	1,00	1,00	1,00
	1,00	1,00	1,00	1,00	1,00	1,00	1,00	1,00	1,00
	12,60	5,57	0,75	1,02	0,22	0,43	0,66	0,50	0,80
	T	T	M	M	M	M	M	M	M
	380	380	220	220	220	220	220	220	220
	0,80	0,90	0,90	0,90	0,90	0,90	0,90	0,90	0,90
	23,9	9,4	3,8	5,2	1,1	2,2	3,3	2,5	4,0
	1,537	1,537	1,537	1,537	1,537	1,537	1,537	1,537	1,537
	Modulare	Modulare	Modulare	Modulare	Modulare	Modulare	Modulare	Modulare	Modulare
	4x40	4x20	2x10	2x10	2x10	2x10	2x10	2x10	2x10
	C	C	C	C	C	C	C	C	C
	400	200	100	100	100	100	100	100	100
	40,0	20,0	10,0	10,0	10,0	10,0	10,0	10,0	10,0
	10,0	10,0	10,0	10,0	10,0	10,0	10,0	10,0	10,0
	8,815E+03	4,907E+03	4,907E+03	4,907E+03	4,907E+03	4,907E+03	4,907E+03	4,907E+03	4,907E+03
			0,03	0,03	0,03	0,03	0,03	0,03	0,03
						AC3	AC3		AC3
						2x16	2x16		2x16
	FG7	FG7	FG7	FG7	FG7	FG7	FG7	FG7	FG7
	5G16		3G2,5	3G2,5	3G2,5	3G2,5	3G2,5	3G2,5	3G2,5
			1	1	1	1	1	1	1
			70	70	70	50	70	50	50
			2,26	3,09	0,65	0,93	1,96	1,06	1,70
			31	31	31	31	31	31	31
			1,560E+05	1,560E+05	1,560E+05	1,560E+05	1,560E+05	1,560E+05	1,560E+05
			152	152	152	211	152	211	211
			152	152	152	211	152	211	211
			106	106	106	106	106	106	106

REFERENCE NUMBER OF DEVICE	1	2	3	4	5	6	7	8	9	10	11	12
PROJECT NAME	SOB_13											

PLANT INPUT	
FAULT CURRENT ALLEGED ON PANELBOARD	1,537 [kA]
RATED VOLTAGE	400 (V)
RATED FREQUENCY	50 (Hz)
SYSTEM OF NEUTRAL	TT
PANELBOARD NAME	
PBFF2	
DP 31	SEGREGATION 3
NORMATIVE REFERENCE	
SWITCH	CEI EN 60947-2
MODULAR SWITCH	CEI EN 60947-2
	CEI EN 60898
PANELBOARD	CEI EN 60439-1
DIMENSION COPPER BARS	
In=	63 [A] lcc= 10,00[kA]



USER	SWITCH NAME	Q29	Q30	Q31	Q32								
	CIRCUIT NAME	FM10											
	DESCRIPTION OF THE CIRCUIT	Passages 2 floor	Gates automotion	Gates automotion	Spare								
	INSTALLED ELECTRIC POWER [kVA]	0,38											
	INSTALLED ELECTRIC POWER [kW]	0,30											
	COEF. OF CONTEMPORANEITY	1,00											
	COEF. OF UTILISATION	1,00											
	USED ELECTRIC POWER [kW]	0,30											
	THREE OR MONO PHASE SYSTEM	M											
	VOLTAGE [V]	220											
	cos φ	0,80											
	ELECTRICAL CURRENT USED [A]	1,7											
DATA PANELBOARD	lcc ALLEGED [kA]	1,537	1,537	1,537	1,537	1,537	1,537	1,537	1,537	1,537	1,537	1,537	1,537
SWITCH OR DISCONNECTOR	TYPE	Modulare	Modulare	Modulare	Modulare								
	SIZE	2x16	2x6	2x6	2x16								
	CHARATERISTICS	C	C	C	C								
	MAGNETIC RELEASE I _{rm} [A]	160	60	60	160								
	THERMAL RELEASE I _{rh} [A]	16,0	6,0	6,0	16,0								
RESIDUAL CURRENT DEVICE	BREAKING CAPACITY [kA]	10,0	10,0	10,0	10,0								
	I _{Δt} [A²s]	4,907E+03	3,707E+03	3,707E+03	4,907E+03								
COMMAND DEVICE	RATED SENSITIVITY [A]	0,03	0,03	0,03	0,03								
	DELAY [ms]												
THERMAL RELAY	TYPE												
	N. POLES x I _n [A]												
FUSE	THERMAL RELEASE I _{rh} [A]												
	N. POLI x I _n [A]												
CONNECTION	SIZE [mm²]												
	SETTING	B											
	TYPE	FG7											
	NO. OF CORES X AREA [mm²]	3G4											
	GROUND WIRE (GW) [mm²]												
WIRE	NO. OF WIRE X POLE	1											
	LENGTH [m]	60											
	Δ V% [%]	0,48											
CHECK	CURRENT CARRYING CAPACITY [A]	42											
	K² S² [A²t]	3,994E+05											
	MINIMUM lcc [A]	280											
	MAX lcc [A]	280											
WIRE	MAXIMUM LENGTH CHECKED [m]	107											

PROJECT NAME SOB_13

PLANT INPUT	
FAULT CURRENT ALLEGED ON PANELBOARD	1,537 [kA]
RATED VOLTAGE	400 (V)
RATED FREQUENCY	50 (Hz)
SYSTEM OF NEUTRAL	TT
PANELBOARD NAME	
PBFF2	
DP 31	SEGREGATION 3
NORMATIVE REFERENCE	
SWITCH	CEI EN 60947-2
MODULAR SWITCH	CEI EN 60947-2
	CEI EN 60898
PANELBOARD	CEI EN 60439-1
DIMENSION COPPER BARS	
I_n	63 [A]
I_{cc}	10,00 [kA]

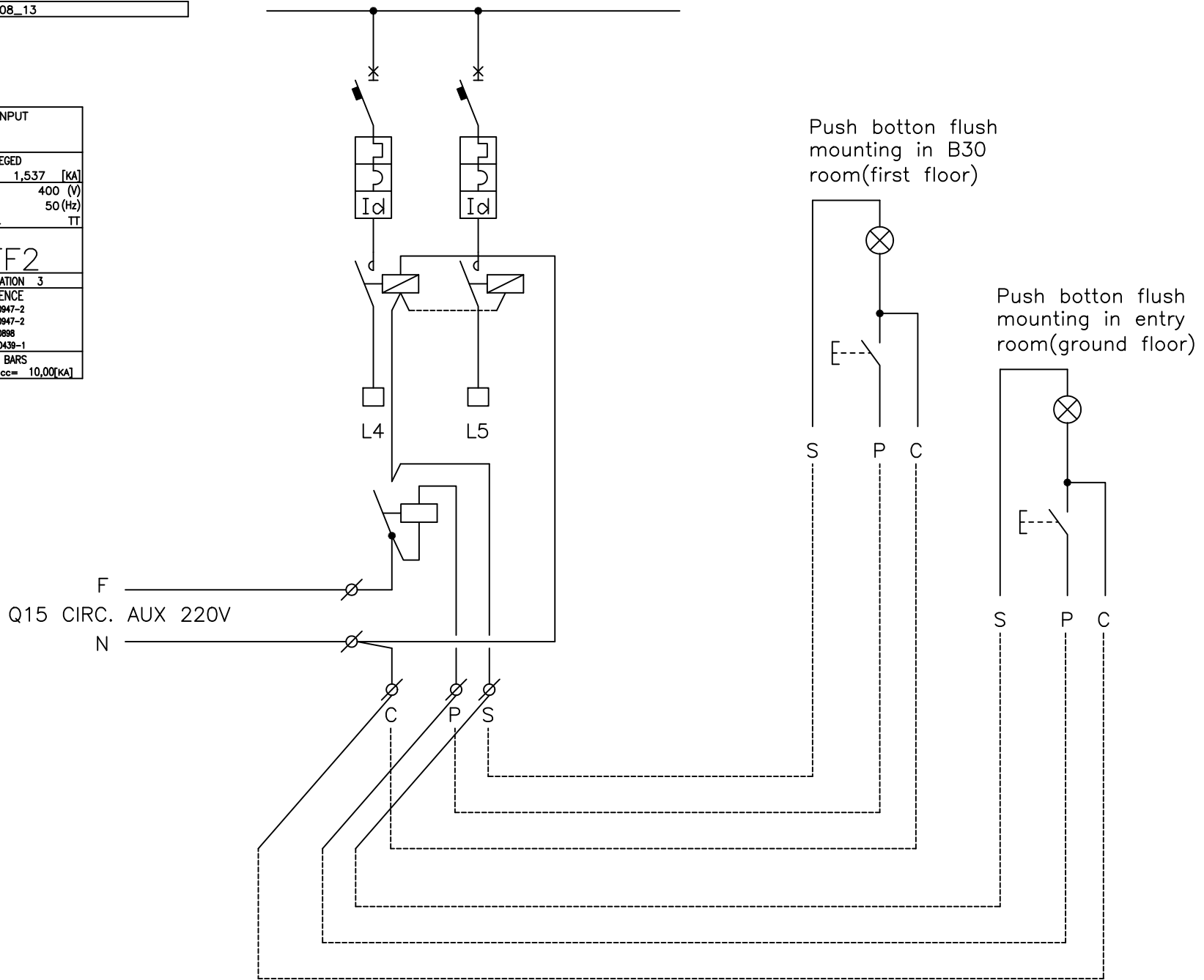

PROJECT NAME SOB_13

PLANT INPUT	
FAULT CURRENT ALLEGED ON PANELBOARD	14,00 [KA]
RATED VOLTAGE	400 (V)
RATED FREQUENCY	50 (Hz)
SYSTEM OF NEUTRAL	TT
PANELBOARD NAME	
PPB	
DP 31	SEGREGATION 3
NORMATIVE REFERENCE	
SWITCH	CEI EN 60947-2
MODULAR SWITCH	CEI EN 60947-2
	CEI EN 60898
PANELBOARD	CEI EN 60439-1
DIMENSION COPPER BARS	
In=	400 [A] lcc= 15,00[KA]

PANEL NAME
Principal Panel Board

CLIENT :



















































Benghazi - Libia

OBJECT :

City Hall Restoration

TABLE: 05

LEGEND SYMBOLS

SYMBOL	DESCRIPTION	SYMBOL	DESCRIPTION	SYMBOL	DESCRIPTION	SYMBOL	DESCRIPTION
	BATTERY ACCUMULATORI		PUSH SWITCH NO N.A.		CONTACTOR		METER
	RECTIFIER RADDRIZZATORE		PUSH SWITCH NC N.C.		PHASE WIRE		AMPEROMETRIC AND AMMETRIC SWITCH
	INVERTER C.C. - A.C.		SIGNAL LAMP		NEUTRAL WIRE		RELAY
	CONTROL ISOLATION "ISOLTESTER"		ELECTRIC SIREN		EXTRACTABLE SWITCH		DELAY TO DISEXCITATION RELAY
	AUXILIARY CONTACT NO		FUSE		SAFETY ISOLATING TRASFORMERS		DELAY TO EXCITATION RELAY
	AUXILIARY CONTACT NC		DIODE		TRANSFORMER		TWILIGHT SWITCH
	AUXILIARY CONTACT OF THERMAL RELAY NO		AUTOMATIC CIRCUIT BREAKER		RIDUTTORE DI CORRENTE (TA)		THREE PHASE MOTOR A.C.
	AUXILIARY CONTACT OF THERMAL RELAY NC		ISOLATOR		EARTH CONNECTION		MONO PHASE MOTOR A.C.
	AUXILIARY CONTACT TIMED TO THE EXCITATION NO		MAGNETIC AND THERMAL SWITCH		KEY LOCK		THREE PHASE CAPACITOR
	AUXILIARY CONTACT TIMED TO THE EXCITATION NC		MAGNETIC, THERMAL AND RESIDUAL CURRENT SWITCH		LOCK		
	AUXILIARY CONTACT TIMED TO THE DISEXCITATION NO		RESIDUAL CURRENT SWITCH		TIME SWITCH		
	AUXILIARY CONTACT TIMED TO THE DISEXCITATION NC		SWITCH		TERMINAL		
	PROXIMITY SWITCH NO		FUSE-DISCONNECTOR		VOLTMETER		
	PROXIMITY SWITCH NC		EARTHING SWITCH		AMPEROMETER		

PROJECT NAME SOB_13

PLANT INPUT	
FAULT CURRENT ALLEGED ON PANELBOARD	14,00 [kA]
RATED VOLTAGE	400 (V)
RATED FREQUENCY	50 (Hz)
SYSTEM OF NEUTRAL	TT
PANELBOARD NAME	
PPB	
DP 31	SEGREGATION 3
NORMATIVE REFERENCE	
SWITCH	CEI EN 60947-2
MODULAR SWITCH	CEI EN 60947-2 CEI EN 60898
PANELBOARD	CEI EN 60439-1
DIMENSION COPPER BARS	
$I_n = 400$ [A]	$I_{cc} = 15,00$ [kA]

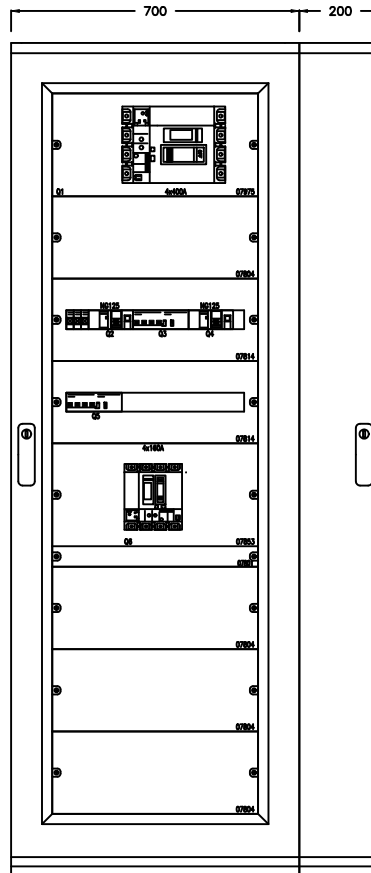

DIMENSION PANEL

HEIGHT [mm] : 2.000 BREADTH [mm] : 900 DEPTH[mm] : 400

PROJECT NAME SOB_13

PLANT INPUT	
FAULT CURRENT ALLEGED ON PANELBOARD	6,577 [KA]
RATED VOLTAGE	400 (V)
RATED FREQUENCY	50 (Hz)
SYSTEM OF NEUTRAL	TT
PANELBOARD NAME	
PBHAVC	
DP 31	SEGREGATION 3
NORMATIVE REFERENCE	
SWITCH	CEI EN 60947-2
MODULAR SWITCH	CEI EN 60947-2
	CEI EN 60898
PANELBOARD	CEI EN 60439-1
DIMENSION COPPER BARS	
In=	250 [A] Icc= 10,00[KA]

PANEL NAME
Panel Board HAVC

CLIENT :



















































Benghazi - Libia

OBJECT :

City Hall Restoration

TABLE: 06

LEGEND SYMBOLS

SYMBOL	DESCRIPTION	SYMBOL	DESCRIPTION	SYMBOL	DESCRIPTION	SYMBOL	DESCRIPTION
	BATTERY ACCUMULATORI		PUSH SWITCH NO N.A.		CONTACTOR		METER
	RECTIFIER RADDRIZZATORE		PUSH SWITCH NC N.C.		PHASE WIRE		AMPEROMETRIC AND AMMETRIC SWITCH
	INVERTER C.C. - A.C.		SIGNAL LAMP		NEUTRAL WIRE		RELAY
	CONTROL ISOLATION "ISOLTESTER"		ELECTRIC SIREN		EXTRACTABLE SWITCH		DELAY TO DISEXCITATION RELAY
	AUXILIARY CONTACT NO		FUSE		SAFETY ISOLATING TRASFORMERS		DELAY TO EXCITATION RELAY
	AUXILIARY CONTACT NC		DIODE		TRANSFORMER		TWILIGHT SWITCH
	AUXILIARY CONTACT OF THERMAL RELAY NO		AUTOMATIC CIRCUIT BREAKER		RIDUTTORE DI CORRENTE (TA)		THREE PHASE MOTOR A.C.
	AUXILIARY CONTACT OF THERMAL RELAY NC		ISOLATOR		EARTH CONNECTION		MONO PHASE MOTOR A.C.
	AUXILIARY CONTACT TIMED TO THE EXCITATION NO		MAGNETIC AND THERMAL SWITCH		KEY LOCK		THREE PHASE CAPACITOR
	AUXILIARY CONTACT TIMED TO THE EXCITATION NC		MAGNETIC, THERMAL AND RESIDUAL CURRENT SWITCH		LOCK		
	AUXILIARY CONTACT TIMED TO THE DISEXCITATION NO		RESIDUAL CURRENT SWITCH		TIME SWITCH		
	AUXILIARY CONTACT TIMED TO THE DISEXCITATION NC		SWITCH		TERMINAL		
	PROXIMITY SWITCH NO		FUSE-DISCONNECTOR		VOLTMETER		
	PROXIMITY SWITCH NC		EARTHING SWITCH		AMPEROMETER		

PROJECT NAME SOB_13

PLANT INPUT	
FAULT CURRENT ALLEGED ON PANELBOARD	6,577 [kA]
RATED VOLTAGE	400 (V)
RATED FREQUENCY	50 (Hz)
SYSTEM OF NEUTRAL	TT
PANELBOARD NAME	
PBHAVC	
DP 31	SEGREGATION 3
NORMATIVE REFERENCE	
SWITCH	CEI EN 60947-2
MODULAR SWITCH	CEI EN 60947-2 CEI EN 60898
PANELBOARD	CEI EN 60439-1
DIMENSION COPPER BARS	
ln=	250 [A] lcc= 10,00[kA]

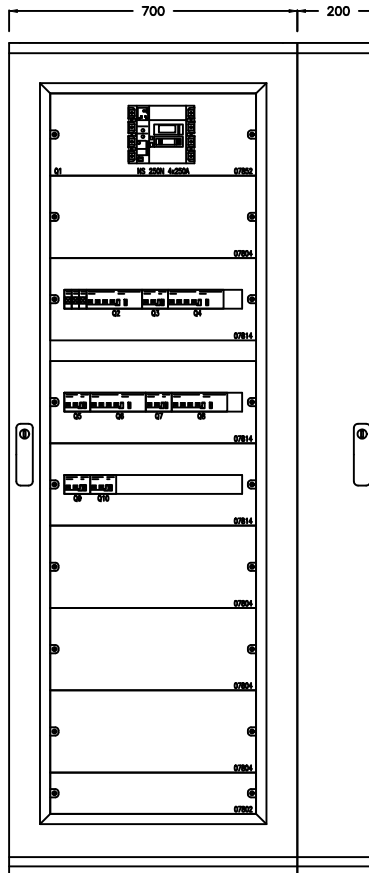

DIMENSION PANEL			
HEIGHT [mm] :	2.000	BREADTH [mm] :	900
DEPTH[mm] :	400		

